

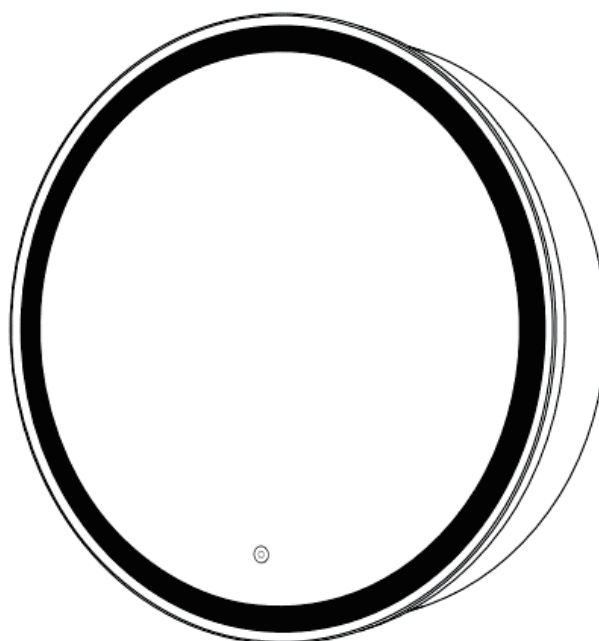

Thank you for choosing Better Bathrooms.
Please read this manual before installing your product
and keep for future reference.

better 
bathrooms

LED BATHROOM MIRROR WITH SLIDING DOOR



ELARA600

ELARABB600

- TOUCH CONTROL
- DEMISTER
- IP44 INGRESS PROTECTION
- SLIDING DOOR

CONGRATULATIONS ON YOUR PURCHASE

Our aim at Better Bathrooms is to bring you extraordinary bathroom products, for less.

If you're after a modern, traditional, or a totally unique style bathroom, we have the fittings and fixtures to bring your ideas to life, so you can fall in love with your space every day.

We hope your new product goes above and beyond your expectations. However, should any problems occur, please:

- Log in to your account and contact our customer services team via your self-service portal – betterbathrooms.com/CustomerAccount/Login
- Contact us via betterbathrooms.com/contact/contact-us

CONTENTS

SAFETY	3
BATHROOM ZONES	4
PARTS SUPPLIED	5
TOOLS REQUIRED	5
INSTALLING THE MIRROR	6
OPERATION	9
TECHNICAL SPECIFICATIONS	10
PRODUCT DIMENSIONS	11

SAFETY

- This mirror should be installed by a qualified electrician.
- This fitting is only suitable for connection to a 220-240V earthed supply in accordance with current IEE wiring regulations, and should be installed in accordance with local Building Regulations.
- This is for domestic, indoor use only.
- The fitting should be connected to a dedicated lighting circuit which must be protected by a 5-amp fuse (or a 6-amp miniature circuit breaker).
- Before installing the fitting ensure the mains supply is switched off, and that the appropriate fuse is removed (or appropriate circuit breaker is switched off) before commencing installation. Ensure that measures are taken to prevent the supply from being inadvertently reconnected.
- If there is a “Minimum Distance” Label, please do not allow Flammable Materials to rest within that distance from the unit.
- This product may contain delicate parts – be careful during handling and maintenance to avoid breakage.
- If any modification is made to the fitting it will invalidate the warranty and may render the product unsafe.
- A defective appliance may cause electric shock. Never switch on a defective or damaged appliance. Disconnect the appliance from the mains before seeking assistance.
- This product is IP44 rated, and no part of the installation is allowed to be within bathroom Zones 0 or 1. Installation is permitted within Zone 2.
- This product must be earthed. Before commencing installation, ensure that there are no pipes or wires located behind the wall that may be damaged during drilling.
- Ensure that the hanging location has been decided upon and marked clearly to avoid unwanted damage in the wall due to incorrect positioning.
- Check that the mirror is not damaged prior to installation.
- Take care unpacking, do not use a sharp blade to open as this may damage the mirror and void your warranty.
- Installation must only be carried out by a qualified professional or electrician.
- Once installed, silicon can be applied between the cabinet and the wall around the unit. Don't seal the bottom of the cabinet, as this may allow for water to accumulate behind the cabinet.

BATHROOM ZONES

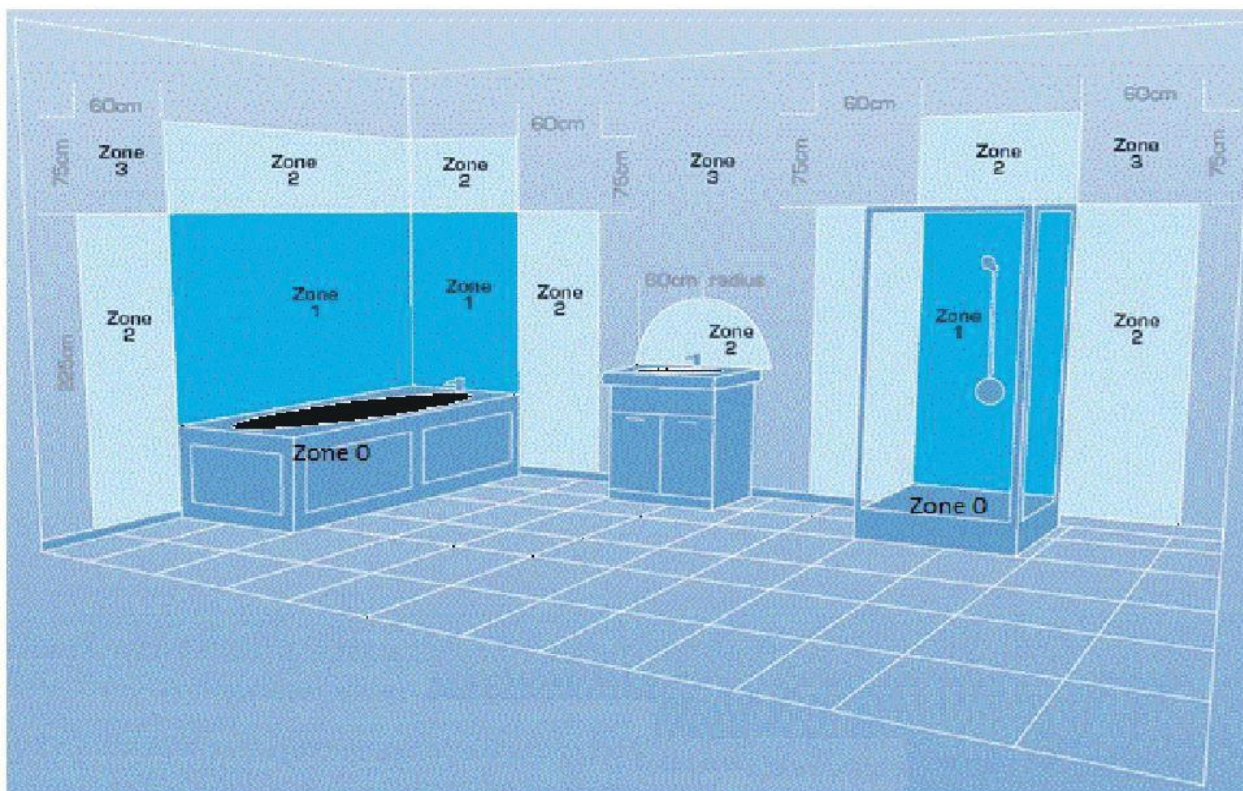

Zone 0:	The interior of the bathtub or shower basin.
Zone 1:	The area around the bathtub or shower basin up to a height of 2.25m above the floor
Zone 2:	The area stretching to 0.6m outside the bath or shower and above the bath or shower if over 2.25m

PARTS SUPPLIED

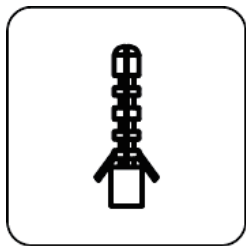

WALL PLUGS (X4)
5mm

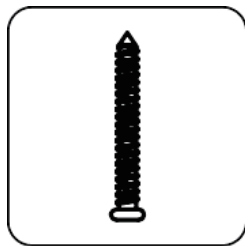

SCREWS M4 (X4)
45mm

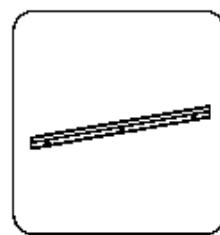

HANGING BAR (X1)

PLEASE NOTE: It is the installers responsibility to ensure that the fittings are suitable for the type of wall. Alternative fittings may be required (Not Supplied). If unsure professional advice should be sought.

TOOLS REQUIRED

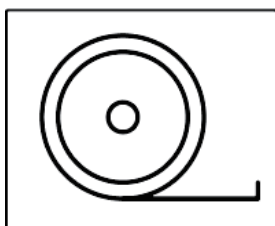

TAPE MEASURE

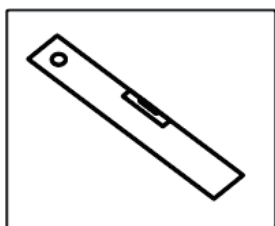

SPIRIT LEVEL

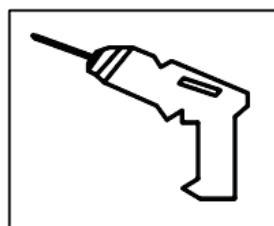

ELECTRIC DRILL

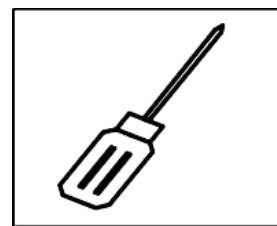

SCREWDRIVER

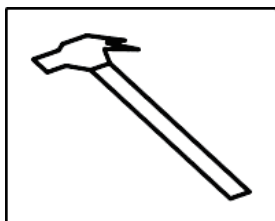

HAMMER

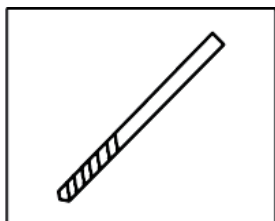

8mm DRILL BIT

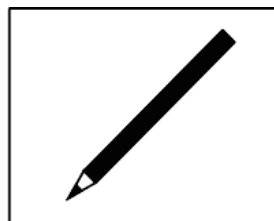

PENCIL

INSTALLATION

IMPORTANT: Before commencing installation, ensure that there are no pipes or wires located behind the wall that you will be drilling into. The depth of the holes needed for hanging are approximately 50mm.

Please ensure that enough space is left for the sliding door to open after installation. Product dimensions can be found on page 11.

- Ensure that the hanging location has been decided upon and marked clearly to avoid unwanted damage in the wall due to incorrect positioning.
- Check that the mirror is not damaged prior to installation.
- Take care unpacking, do not use a sharp blade to open as this may damage the mirror and void your warranty.

Please note: The maximum safe loading weight for the unit is 10.5kg.

Please note: The maximum safe loading weight for each shelf is 3.5kg.

The cabinet is supplied with a hanging bar to mount the cabinet onto the wall. At the back of the cabinet there is a corresponding bar which is designed to slot onto the hanging bar.

- 1 Choose the desired position of the cabinet, and from that determine the required position of the hanging bar.

- 2 Use a pencil to mark the position of the 3 holes on the wall.

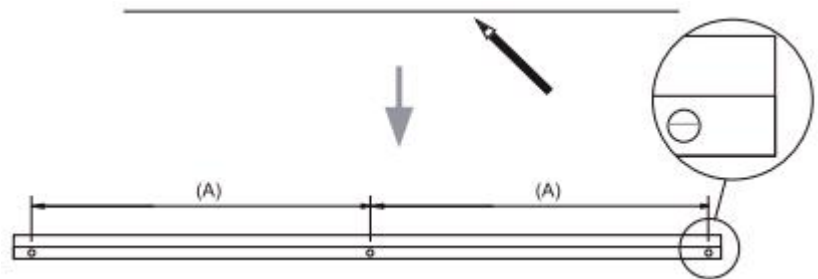

- 3 Hold the hanging bar in position, using a spirit level to ensure it is level.
- 4 Place the hanging bar to one side and drill the holes with a suitable drill bit.
- 5 Insert wall plugs into the holes, ensuring they are flush to the wall.
- 6 Place the hanging bar onto the wall, lining up the 3 holes with the wall plugs

7

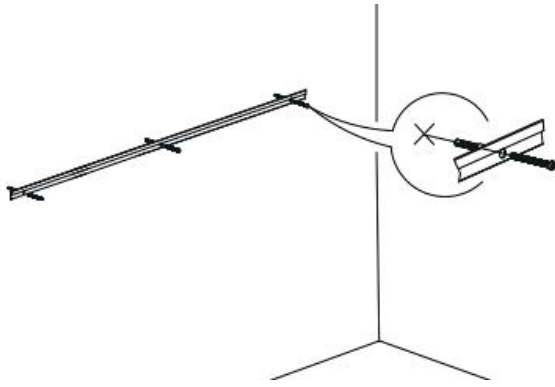

Secure the hanging bar to the wall using the supplied screws.

8

You will now be able to hang the cabinet. Carefully lower the cabinet onto the hanging bar, ensuring that is secure and will not slide.

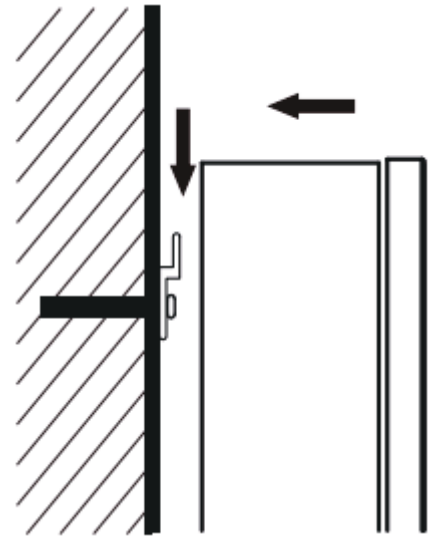

9

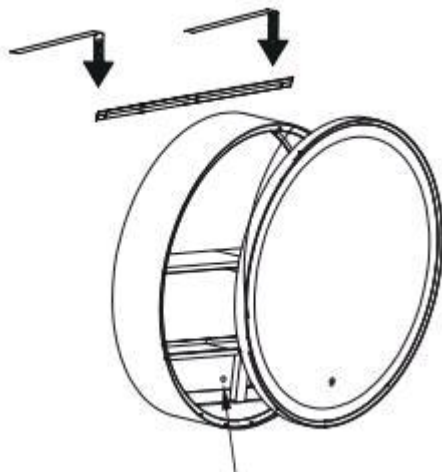

Open the cabinet door and mark the wall with a pencil through the security hole on the back panel.

- 10** Remove the cabinet, drill the hole then place a wall plug into the hole you have just drilled.



- 11** Hang your cabinet back up onto the hanging bar and ensure that the in the cabinet is lined up with the wall plug.

- 12** The cabinet should now be connected to a suitable fused spur following current regulations and guidance. We would advise this to be situated directly behind the cabinet below the hanging bar. When connecting ensure that enough cable is left to allow the cabinet to be safely removed from the hanging bar.

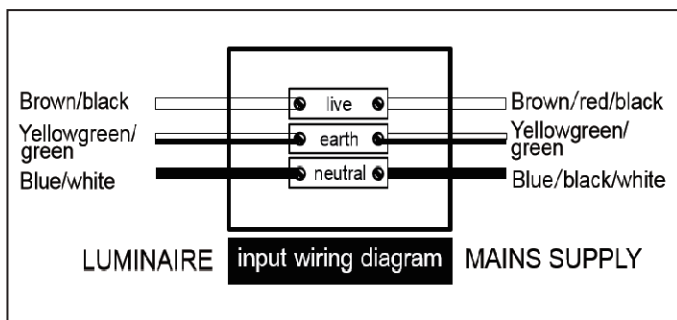

- 13** Secure the cabinet to the wall using a screw through the security hole and into the wall plug you previously installed.



OPERATION

Your mirror has a touch switch towards the base of the mirror. Tap it once to turn on the lights and the demister. Tap again to turn off the lights and demister.

Hold down the button to change the lights from warm white to cool white and back again.



CLEANING AND MAINTENANCE

Never use products containing bleach or abrasive cleaners, as this will have a detrimental effect on the appearance and lifespan of the product.

Use a clean microfibre cloth to clean the mirror.

TECHNICAL SPECIFICATION

Model	ELARA600 ELARABB600
WxHxD (mm)	608x608x155
Net Weight (Kg)	10.1
Power Cord length (cm)	62
Rated Power (W)	25W
IP Rating	IP 44
Input	220 V-240 V 50 Hz

This product contains a light source of energy efficiency class F.

DISPOSAL

Recycling facilities are now available for all customers at which you can deposit your old electrical products. Customers will be able to take any old electrical equipment to participating sites run by their local councils.

Please remember that this equipment will be further handled during the recycling process, so please be considerate when depositing your equipment. Please contact the local council for details of your local household waste recycling centers.

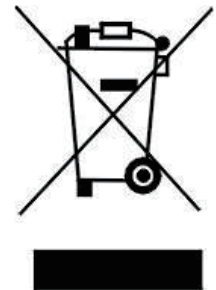

At the time of printing the product contains no substances listed within Annex XIV of the Reach Regulations (EC) 1907/2006. In accordance with Article 59 of the same regulation the following substances are contained within the product at permitted levels: Cadmium.

As a responsible manufacturer the regulations are monitored to ensure continued compliance. Further information can be provided upon request.

For more information

- visit betterbathrooms.com
- email customerservices@buyitdirect.co.uk
- call 0330 390 3062
- write to Trident Business Park, Neptune Way, Huddersfield, HD2 1UA

**better
bathrooms**

Part of the BuyItDirect Group

